

SOTERIA®  
DETECTION > DEFINED

INTELLIGENCE  
> DEFINED

EFFICIENCY  
> DEFINED

REFINEMENT  
> DEFINED

DETECTION  
> DEFINED

INTEGRATION  
> DEFINED

SOTERIA®  
DETECTION > DEFINED

SOTERIA®,  
POWERED BY COREPROTOCOL®  
APOLLO'S MOST ADVANCED  
FIRE DETECTION SYSTEM

Apollo Fire Detectors, the world-leading independent fire detector manufacturer, is pleased to present the latest products in its innovative fire detection system range - SOTERIA® and CoreProtocol®.

The SOTERIA® collection offers the next generation in fire recognition technology and has been developed to improve detection, reduce false alarms and deliver improved reliability.

Complementing SOTERIA® is Apollo's enhanced protocol, CoreProtocol®, the next generation in fire loop communication giving greater control, higher levels of efficiency and significantly more loop power.

These new products have been designed by Apollo's industry-leading engineers using the latest simulation technology and in-house development and testing facilities. They reflect our ambition to deliver a real focus on innovation and are just the start of our journey, with more exciting products in the pipeline.

To find out how you can benefit from the peace of mind that our most sophisticated fire detection system to date brings, talk to the Apollo sales team about SOTERIA® and CoreProtocol® today on +44 (0)23 9249 2412 or visit [www.apollo-fire.co.uk](http://www.apollo-fire.co.uk) for our latest updates.



# INNOVATION > DEFINED

## NEXT GENERATION IN FIRE DETECTION

SOTERIA® and CoreProtocol® products have been developed by our UK-based team of professional technical experts and have been stringently tested at our advanced in-house fire test facilities.

At Apollo, we are committed to providing the latest in technology, delivering real benefits and results which are reinforced with our unrivalled technical support.

Currently covering heat and optical detection areas - either individually or in innovative combinations - the exclusive technology incorporated into the SOTERIA® range offers an unrivalled host of benefits, including:

- > Enhanced reliability of smoke detection
- > Reduction in false alarms
- > Simple installation with a new easy-fit base and an isolator located in the head
- > PureLight® technology
- > A sleek and stylish low-profile or flush design
- > Compatible with XP95 & Discovery protocols
- > Comprehensively tested to exceed EN54 standards
- > Extensively tested at Apollo's state of the art in-house testing facilities

# INTELLIGENCE > DEFINED

## FEWER FALSE ALARMS

Using our dedicated team of industry experts, Apollo has developed the SOTERIA® collection to include a range of new features which offer unique benefits to the fire detection market.



### ADVANCED CHIP SENSOR

Applying the latest in electronics, our advanced technology significantly improves the detection of smoke, and enhances reliability of the detection process.



### BETTER PROTECTION FROM INSECTS

Our improved design, which includes a new mesh barrier, makes it harder for insects to enter the device and gives them fewer places to hide.



### STRINGENT TESTING

We carry out comprehensive testing in our own laboratories and testing facilities. Every device is tested beyond EN54 standards to ensure maximum reliability and performance.



### LESS LIGHT INTERFERENCE

SOTERIA® has been designed to stop stray light entering the device and the intelligent internal design reduces reflection inside the inner chamber.



### INCREASED DUST RESISTANCE

The sleek low profile design of SOTERIA® means that less dust penetrates the outer casing. We have also designed SOTERIA® detectors to be less sensitive to any dust that does accumulate over long periods of time.

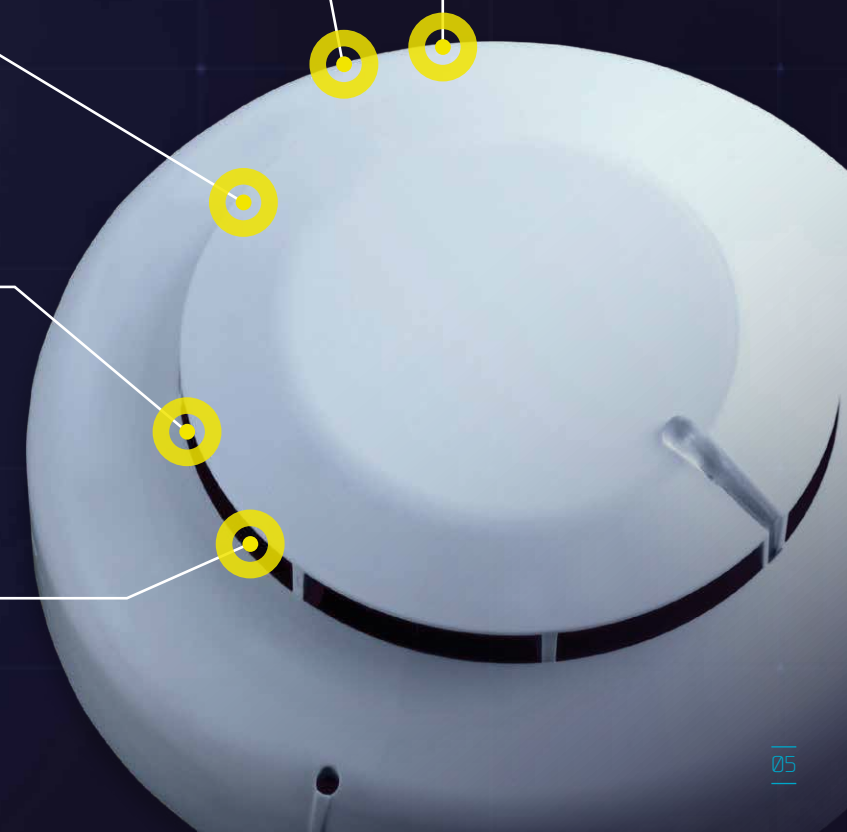



# INTEGRATION > DEFINED

UNIVERSALLY COMPATIBLE



At Apollo, we know that effective fire detection isn't just about the detectors, which is why we've developed our enhanced protocol, CoreProtocol®, the next generation in fire loop communication.

Building on our established XP95 and Discovery technology, CoreProtocol® supports more devices through increased power on the loop and soft addressing. It also boasts enhanced status reporting, reduced installation costs and improved system versatility.

CoreProtocol® offers forward and backward compatibility and the ability to manage a significantly increased number of devices and, when used in conjunction with SOTERIA®, offers improved features.\*

\*Features subject to panel availability and enablement.



## HIGHER LOOP POWER

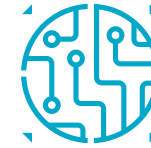

Increased power on the loop allows more devices to be supported – up to a maximum of 2,028 addresses using SOTERIA® devices.

## IMPROVED ENVIRONMENTAL CONTROL

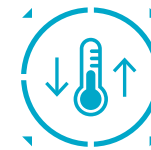

CoreProtocol® provides highly accurate readings e.g. ambient temperature and CO levels, and can forward these to a Building Management System - providing temperature information to within a degree centigrade. This enables the accurate adjustment of air conditioning, heating and building ventilation.



## INTELLIGENT ADDRESSING

SOTERIA® devices incorporate a smart isolator which allows the device to be addressed with automatic addressing and soft addressing options by CoreProtocol®, or via an XPERT card in the device. This smart isolator effectively becomes an electronic switch that can isolate sections on the loop, making fault finding and diagnostics simpler. Additionally, devices can be grouped and triggered independently, for example, to isolate a single floor of a building for maintenance.



## FASTER STATUS REPORTING

CoreProtocol® flags any events triggered on the system to create fast status alerts. Any devices tampered with are instantly identified and a tamper flag created. If the system is triggered, more detailed information is available to help identify why a particular detector was activated.

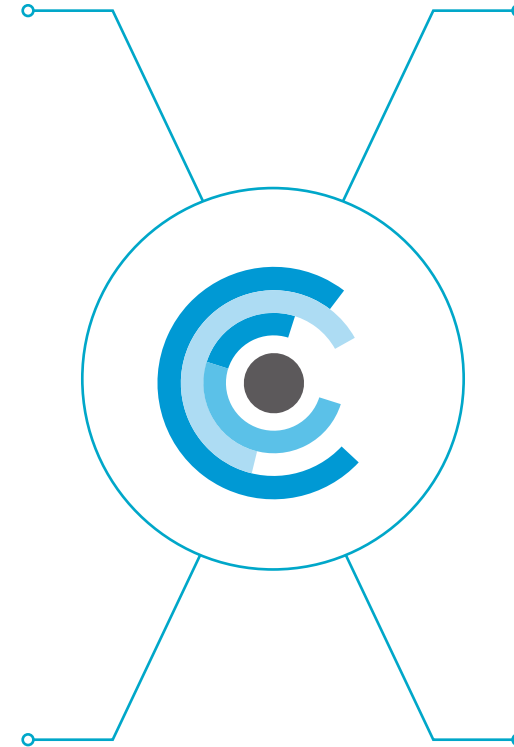

# PURELIGHT® TECHNOLOGY

The standard SOTERIA® detectors use new optical sensing technology, PureLight®, to detect smoke particles entering its chambers in optical and multisensor detectors. This unique system marks a new stage in the development of Apollo optical technology and increases the reliability of fire detection while resulting in fewer false alarms.

## OUR ADVANCED PURELIGHT® FOR OPTICAL AND MULTISENSORS TECHNOLOGY INCLUDES:



### A NEW CONE SENSING CHAMBER

Our innovative Cone technology allows light from the LED to be entirely absorbed, reducing reflections in the chamber.

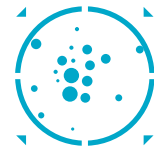

### ENHANCEMENTS TO THE SMOKE ENTRY PROCESS

Our 'serpentine' designed smoke entry path provides a wide degree of separation of smoke and dust, and enables smoke to enter the chamber whilst acting as a barrier to dust and insect ingress.

## HOW PURELIGHT® TECHNOLOGY WORKS

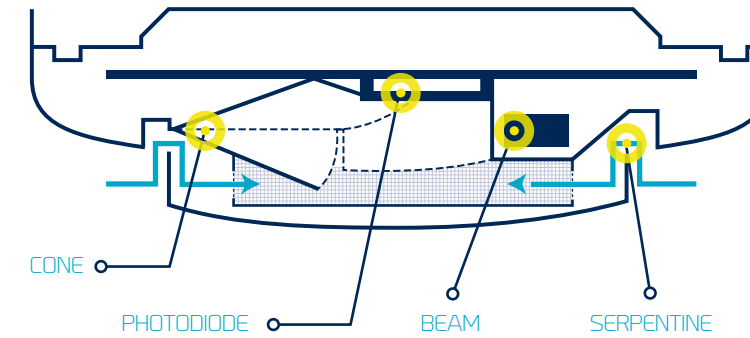

### SERPENTINE DESIGN

The low profile design of the outer casing improves the flow of smoke as well as reducing contamination from dust. The smoke inlet consists of a complex pathway into the centre of the detector, designed using computer simulation to achieve the best airflow in all orientations. This creates a controlled environment around the cone within the detector as well as completely eliminating external light, ensuring the inner chamber remains ultra-dark.

### CONE TECHNOLOGY

The smoke chamber of the detector is a unique cone shape which serves to reduce any stray reflection. This ultra-dark internal light chamber also contains a high-intensity infra-red LED that is highly sensitive to smoke particles. When smoke enters the chamber, infra-red light is scattered and registered by the photodiode and amplifier that are included in an application-specific integrated circuit. This circuit ensures long term reliability, even in extreme conditions.

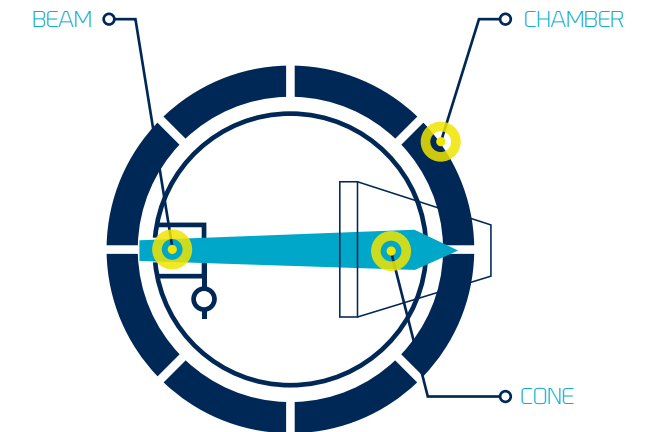



# RIGOROUSLY TESTED

Apollo is the largest independent smoke detection manufacturer in the world, producing over 50,000 detectors every day. Our commitment to safety is clear – our state of the art in-house testing facilities are a critical tool in both the development of new products, and our ongoing rigorous testing methods.

Our innovative SOTERIA® devices have been designed by industry leading engineers using the latest simulation technology in our advanced laboratories. The finished products have been comprehensively tested to exceed EN54-5 and EN54-7 standards and have undergone more than 5,000 engineering test hours and over 120,000 hours of intensive environmental testing.

These stringent testing procedures puts even the tiniest component of each of our detectors through its paces, with each device undergoing testing which far exceeds international benchmarks. This means you can install our devices with the confidence that each and every Apollo detector meets the very highest of standards.



## EN54

TESTED TO EXCEED EN54-5 AND EN54-7 STANDARDS

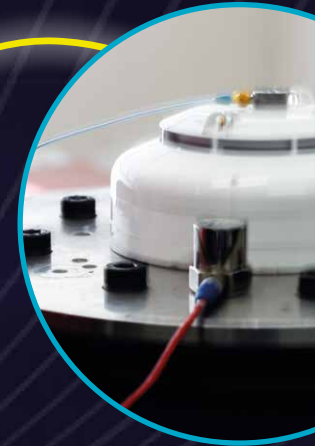

## 120,000

HOURS OF INTENSIVE ENVIRONMENTAL TESTING



## 5,000

EACH DEVICE HAS UNDERGONE MORE THAN 5,000 ENGINEERING TEST HOURS IN PRODUCT DEVELOPMENT

# EFFICIENCY > DEFINED

## SIMPLER INSTALLATION

Our exciting new products may have been developed using the most sophisticated design and manufacturing processes in the world, but installing the standard detectors is simple, and the benefits are significant.

### INCREASED ADDRESSES

All SOTERIA® bases incorporate an 8-bit address card, allowing more addresses.\*

### EASY-FIT BASE TO SAVE TIME AND COSTS

We've situated our isolator in the head of the detector, meaning a single base can be used to fit all devices. This 'Easy-Fit' base is easier to mount, saving on time and costs.

### ISOLATOR LOCATION

Positioning our isolator in the detector head also results in better loop protection.

### FASTER TESTING

A comprehensive set of features supports maintenance and service, from self-testing to drift compensation warnings on dirty detectors. The FasTest® mode allows quicker testing, reducing time from 40 seconds to just 4 seconds to make maintenance faster and simpler.\*

\* Only available with CoreProtocol®





# DETECTION > DEFINED

## CUTTING-EDGE TECHNOLOGY

Dimension fire detectors are sleek, flat optical fire detectors for flush mounting. Apollo's next generation of detectors marry technological innovation and high design resulting in a product compatible with CoreProtocol® and legacy systems.

### SLEEK DESIGN

The Dimension fits flush to the ceiling for limited impact on the architectural aesthetics of buildings.

### A SPECIALIST VERSION

We have designed a tamper proof and anti-ligature version of the standard Dimension detector with custodial and care facilities in mind.

### UNIQUE CHAMBERLESS TECHNOLOGY

Our cutting-edge Dimension detectors utilise chamberless technology instead of the standard chambers found in other detectors for a flush, sleek look.

### EASY TO CLEAN

The detector can be wiped clean with a lint-free cloth to maintain perfect working order and as with all Apollo detectors, the facings will never yellow.

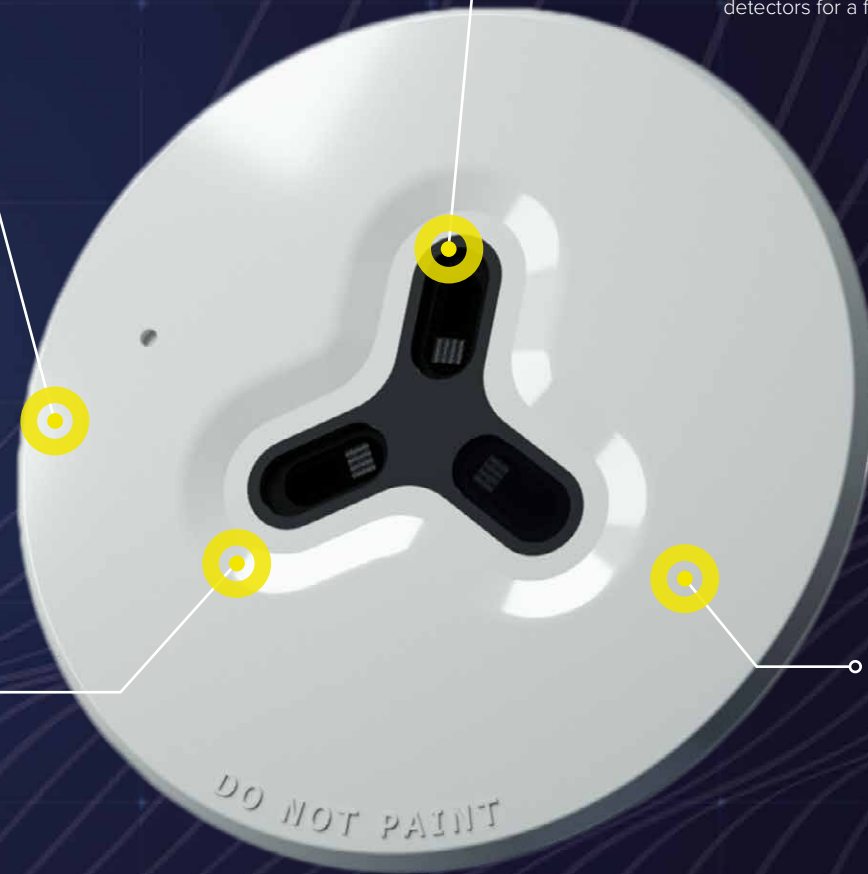



## SYSTEM INTEGRATION

-  DETECTOR / ALARM
-  DETECTOR / FAULT
-  DETECTOR / POLLING

TRI-COLOURED LED STATUS INDICATOR

## POLLING DETECTION

UNIQUE CHAMBERLESS TECHNOLOGY SMOKE DETECTION

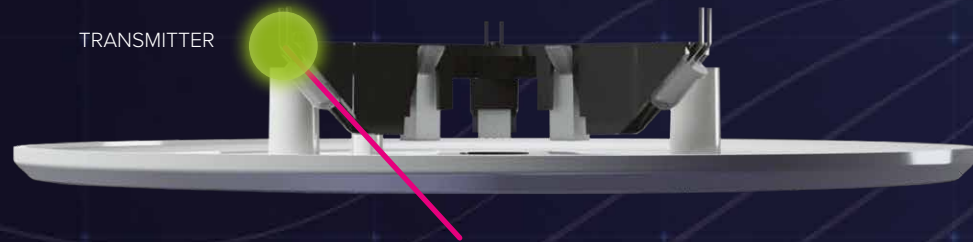

- DETECTION  STATUS

## FAULT DETECTION

INTELLIGENT SENSING OF FOREIGN AND TRANSIENT OBJECTS TO REDUCE FALSE ALARMS

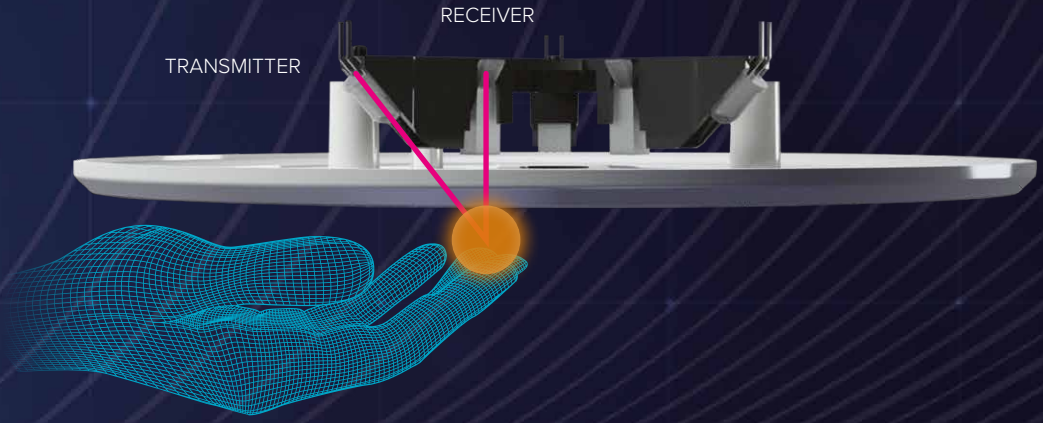

- DETECTION  STATUS

## ALARM DETECTION

PATENTED, UNIQUE CHAMBERLESS TECHNOLOGY FOR RAPID SMOKE DETECTION

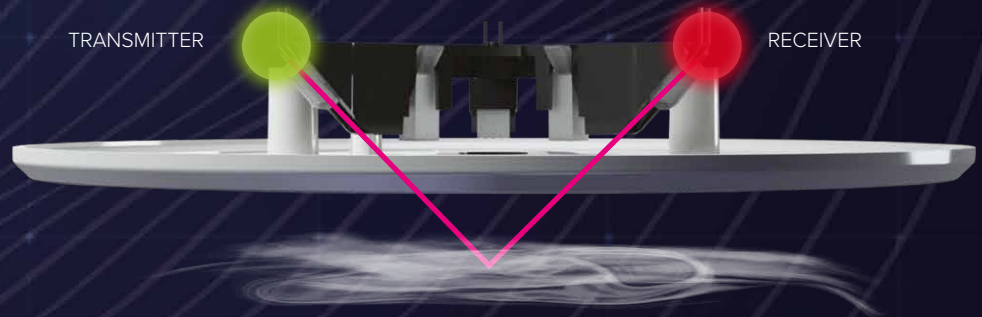

- DETECTION  STATUS

# REFINEMENT > DEFINED

## ADVANCED STYLING

Apollo's next-generation SOTERIA® and CoreProtocol® system is under constant development by our skilled team of industry experts, with many exciting products in the pipeline. Our current range includes:

DIMENSION OPTICAL DETECTOR



FL5100-600APO  
MEASUREMENTS  
140 MM DIAMETER X 71 MM DEPTH  
(WITH BACKBOX)

DIMENSION SPECIALIST OPTICAL DETECTOR

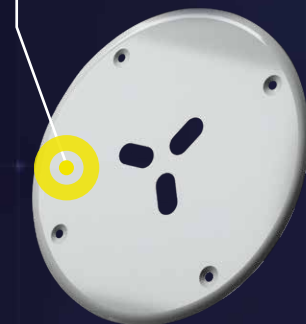

FL6100-600APO  
MEASUREMENTS  
170 MM DIAMETER X 71 MM DEPTH  
(WITH BACKBOX)

DIMENSION BACKBOX

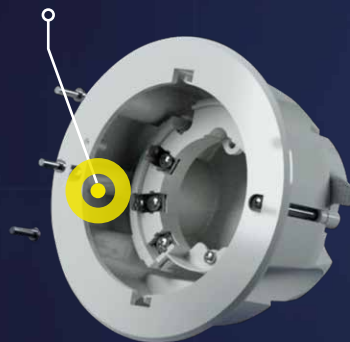

FL5000-200APO  
MEASUREMENTS  
113MM X 71MM DEPTH

HEAT DETECTOR

SA5000-400 (NON ISOLATED)  
SA5100-400 (ISOLATED)

MEASUREMENTS  
100MM DIAMETER X 38.5MM HEIGHT



OPTICAL SMOKE DETECTOR

SA5000-600 (NON ISOLATED)  
SA5100-600 (ISOLATED)

MEASUREMENTS  
100MM DIAMETER X 36MM HEIGHT

OPTICAL/HEAT DETECTOR

SA5000-700 (NON ISOLATED)  
SA5100-700 (ISOLATED)

MEASUREMENTS  
100MM DIAMETER X 38.5MM HEIGHT



XPERT 8 INTELLIGENT MOUNTING BASE

SA5000-200  
XPERT 8 CARD  
38532-054

MEASUREMENTS  
100MM DIAMETER X 12MM DEPTH



Optical Smoke Detector mounted onto base: 48mm total height.

# WORLD CLASS DESIGN

## BROUGHT TO YOU BY APOLLO

Together, the SOTERIA® range and CoreProtocol® system offers a step-change in fire detection, notification and interfacing technology. Used individually or in innovative combinations for supreme effect and efficiency, Apollo's expertise has resulted in a flexible and intelligence-led fire detection system which delivers maximum benefits and greater peace of mind.

Apollo's commitment to innovation will see the SOTERIA® and CoreProtocol® system product range continually evolving to meet market needs over the months and years to come.

To speak to us about how SOTERIA® and CoreProtocol® can benefit you, call +44 (0)23 9249 2412 or visit [www.apollo-fire.co.uk/soteria](http://www.apollo-fire.co.uk/soteria) for our latest updates.



Apollo Fire Detectors Ltd.  
36 Brookside Road  
Havant, Hampshire  
PO9 1JR  
United Kingdom

Tel +44 (0)23 9249 2412  
Fax +44 (0)23 9249 2754  
[enquiries@apollo-fire.com](mailto:enquiries@apollo-fire.com)  
[www.apollo-fire.co.uk](http://www.apollo-fire.co.uk)

